

Fig.5

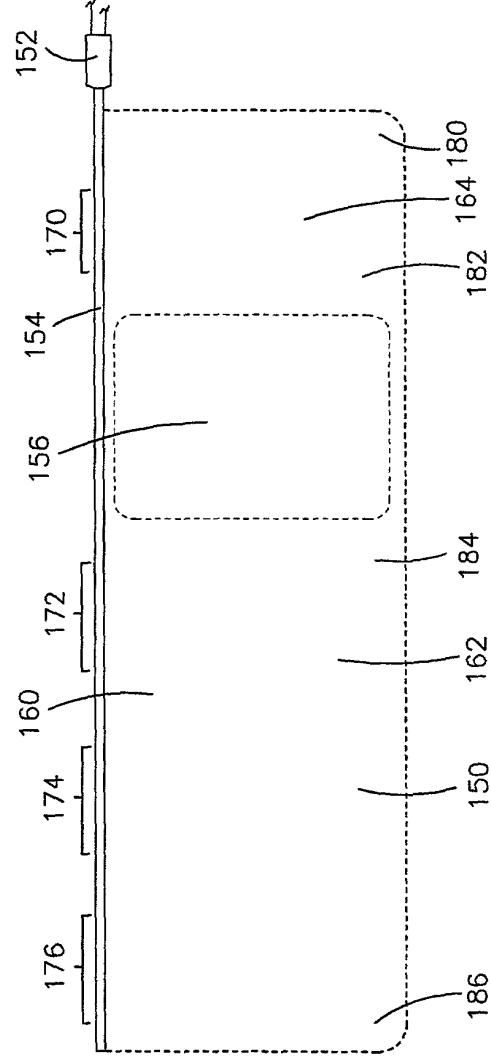

Fig.6

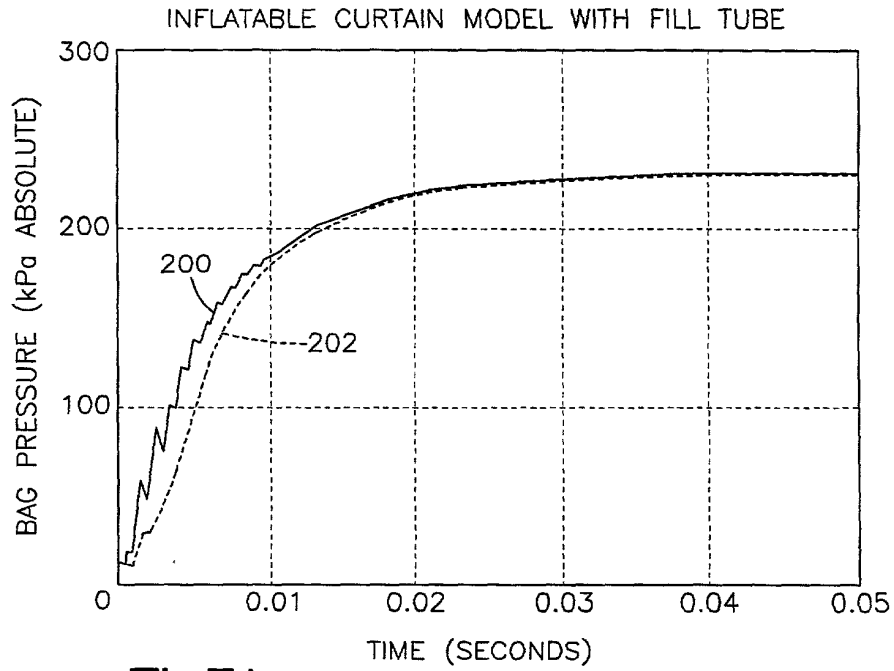

Fig.7A

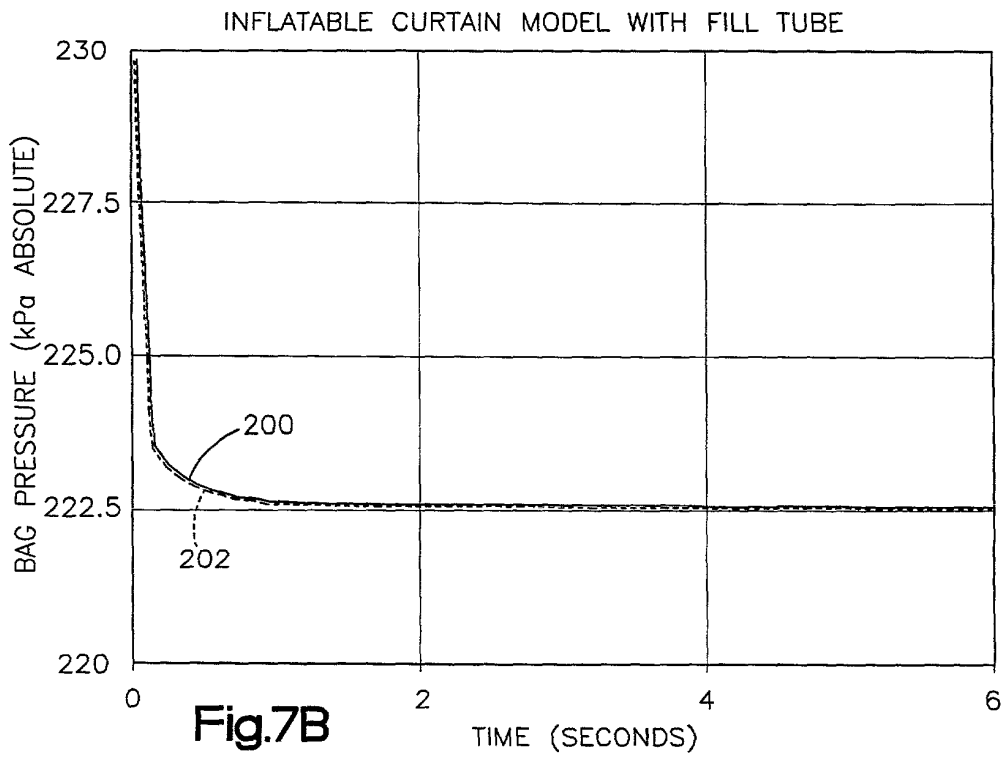

Fig.7B

TRW

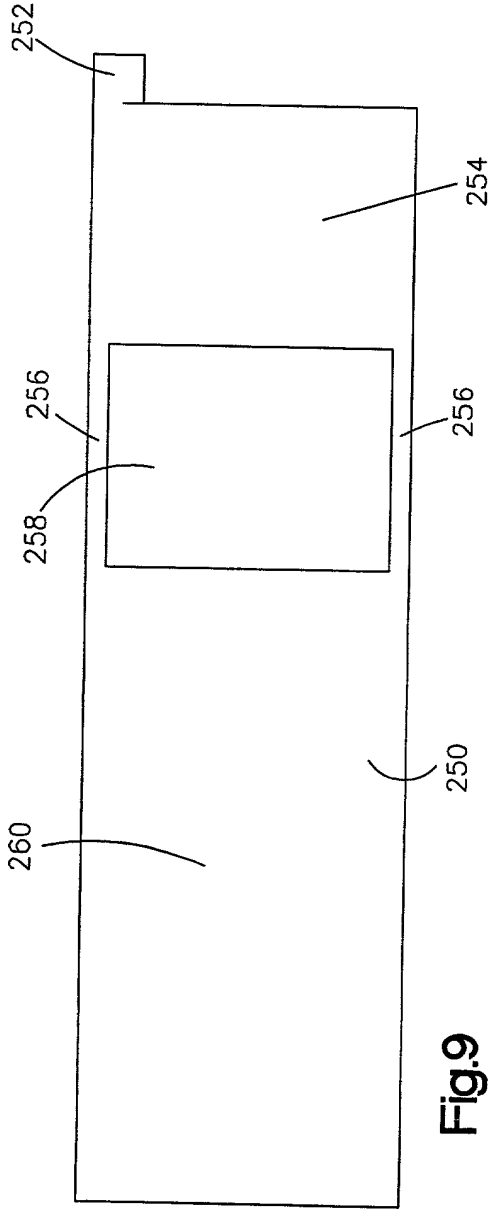

Fig.9

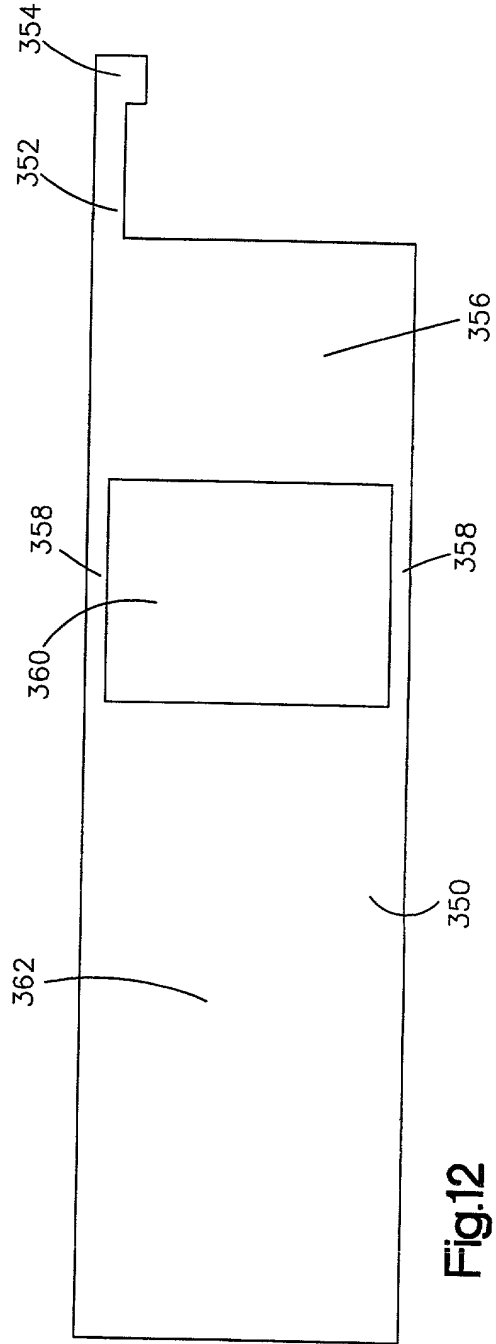

Fig.12

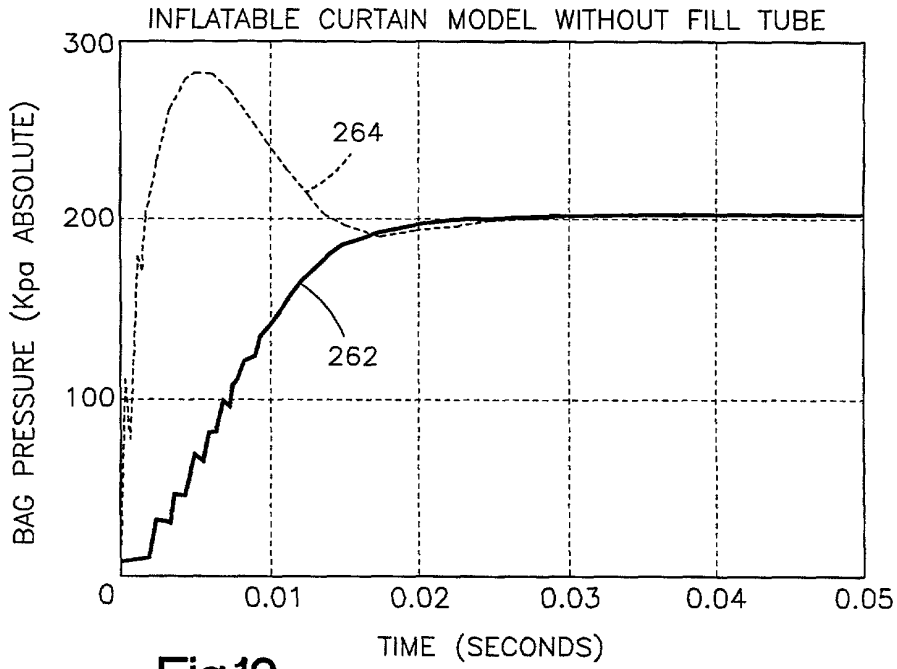

Fig.10

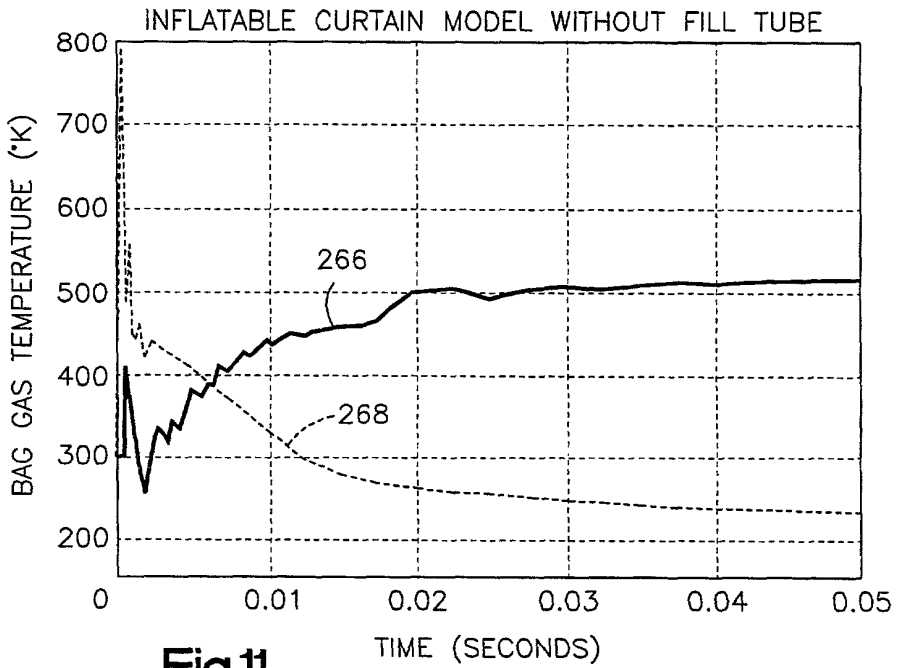

Fig.11

TRW

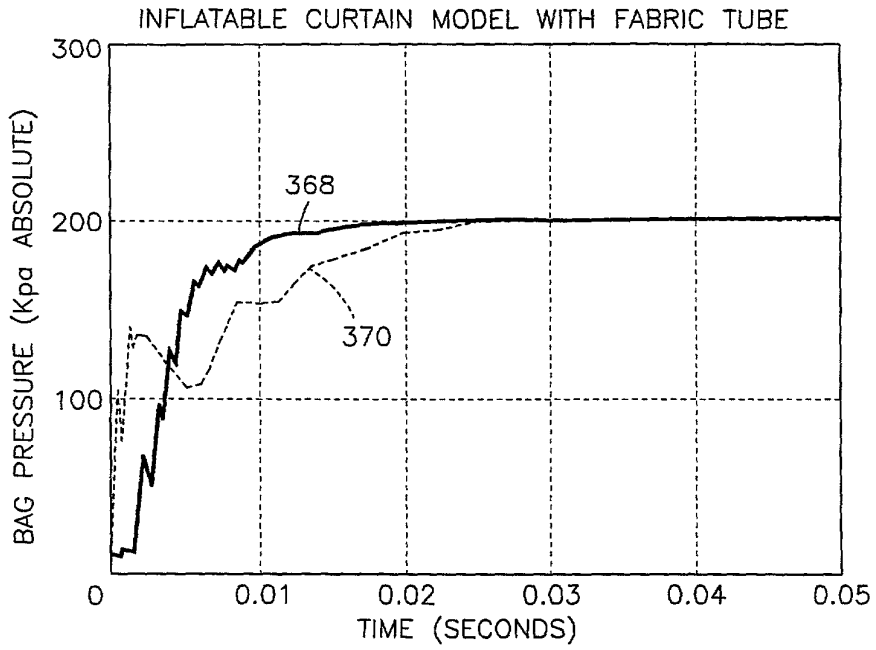

Fig.13

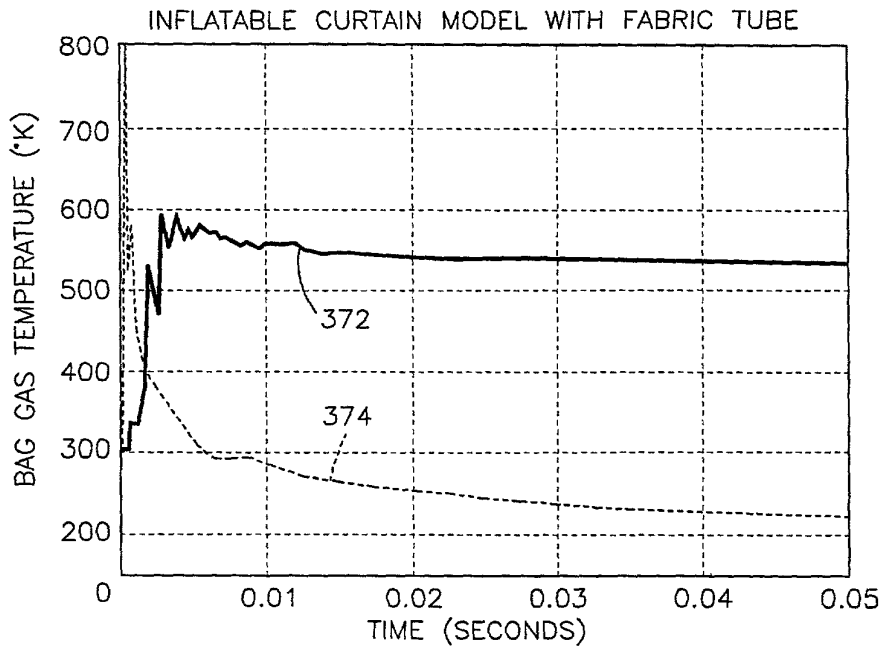

Fig.14

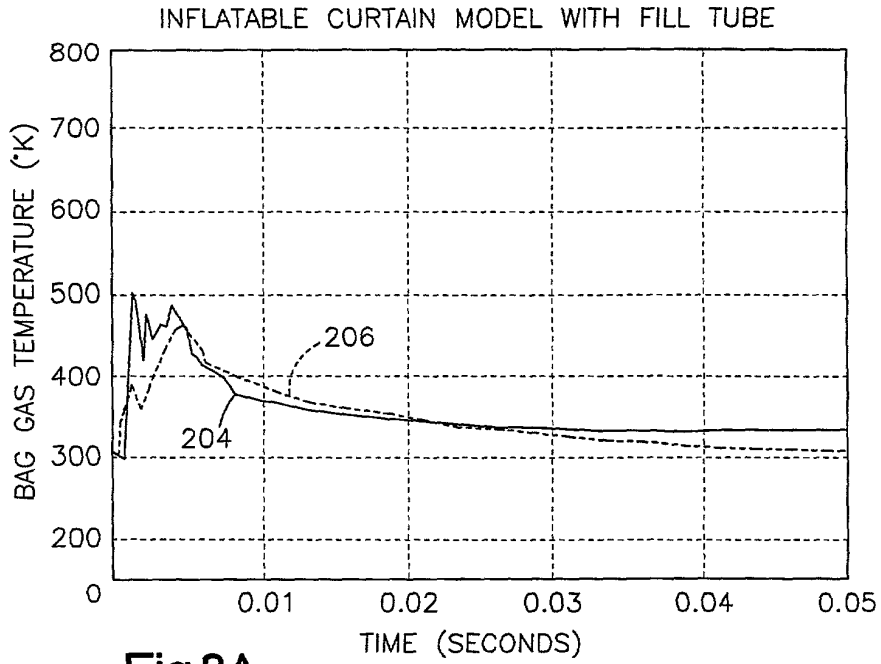

Fig.8A

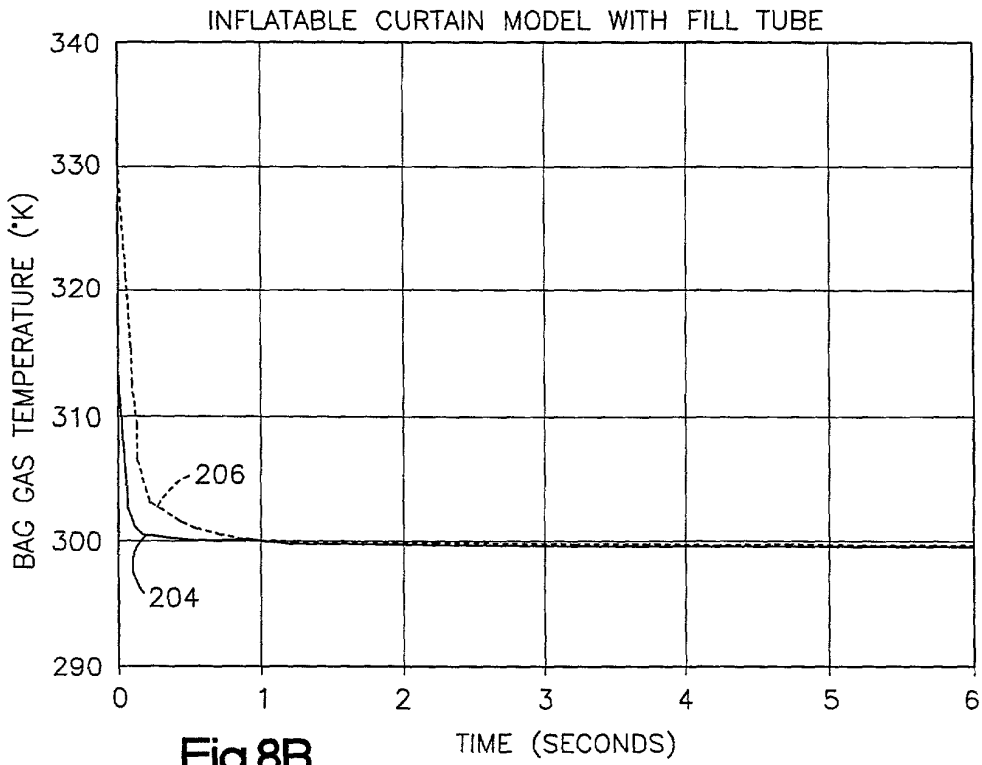

Fig.8B

TRW VSSIM 4719CIP



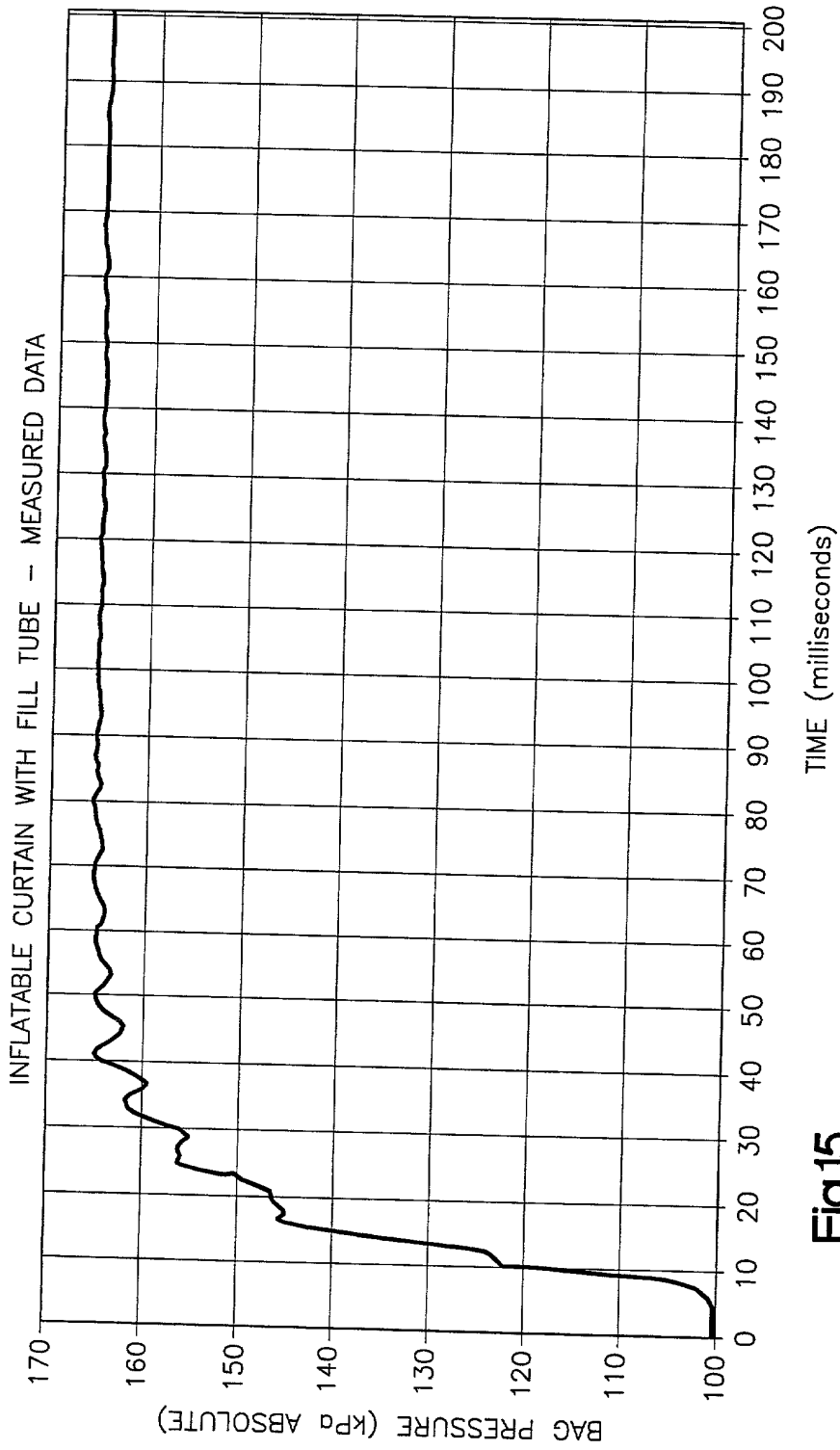

Fig.15

TRW VSSIM 4719CIP

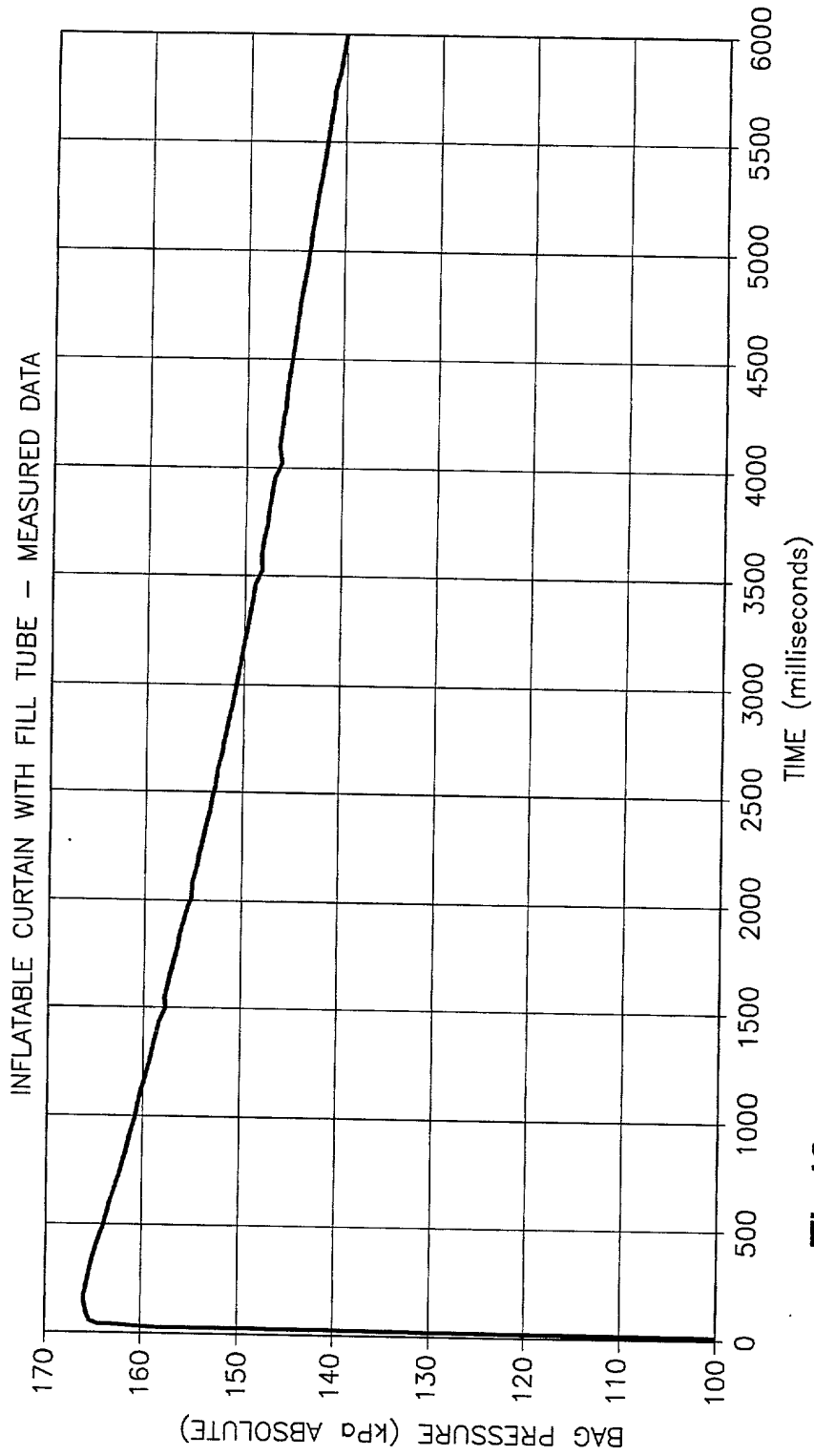

Fig.16

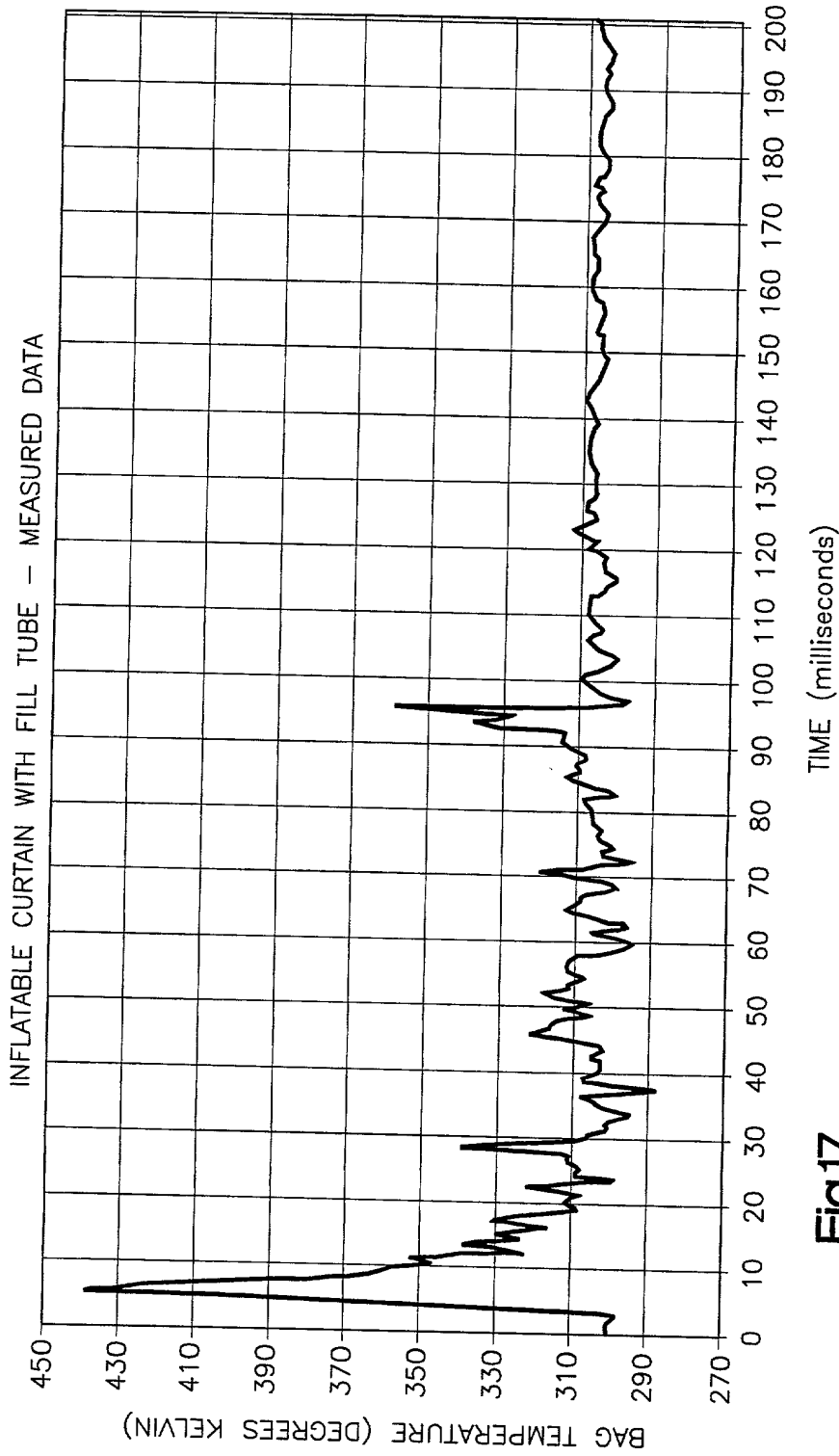

Fig.17

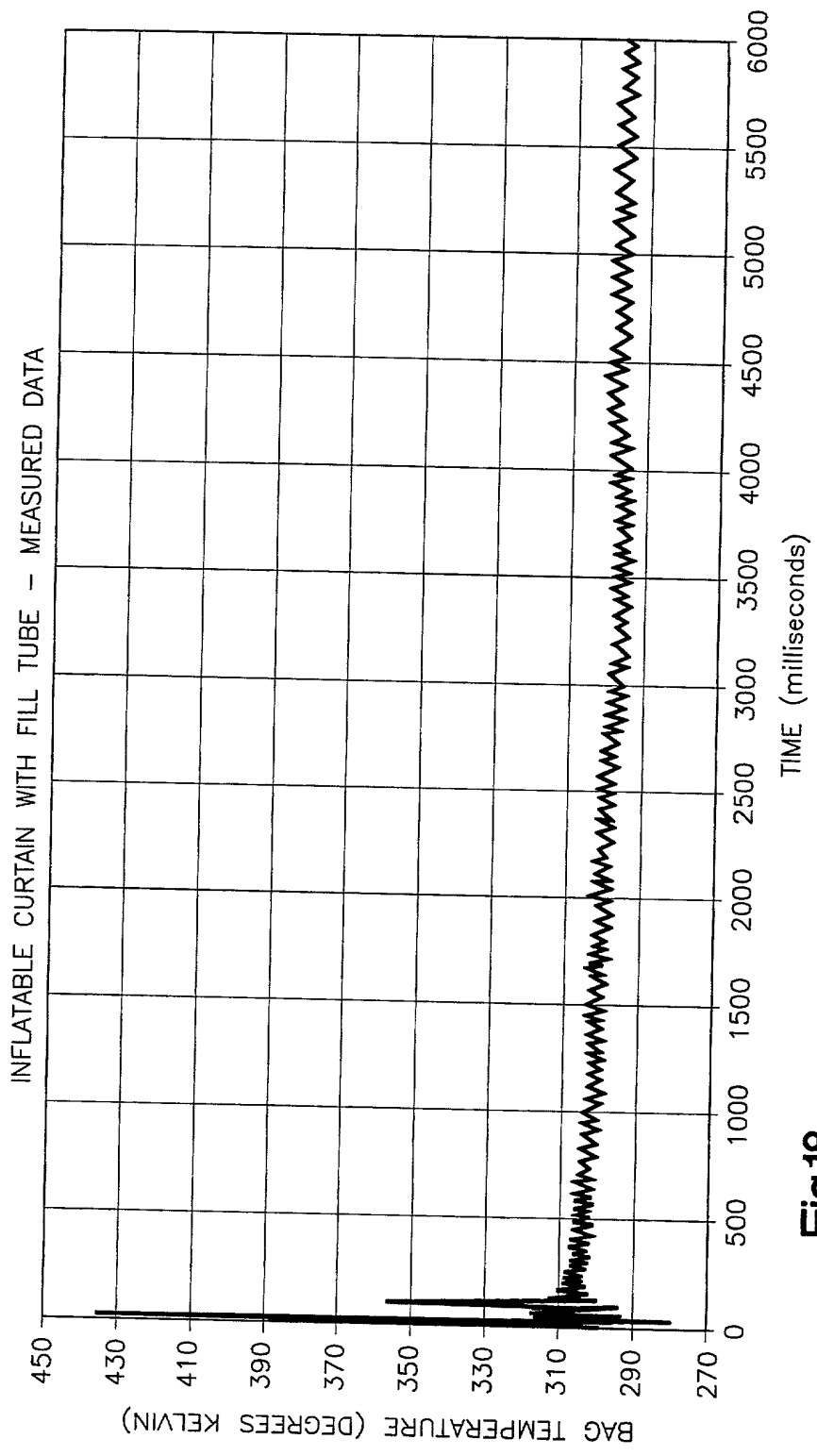

Fig.18